

couverture

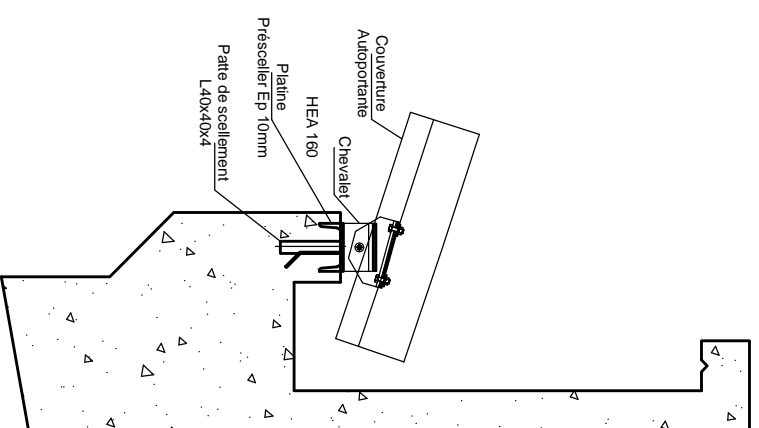

Détail d'étanchiété toiture et Mur

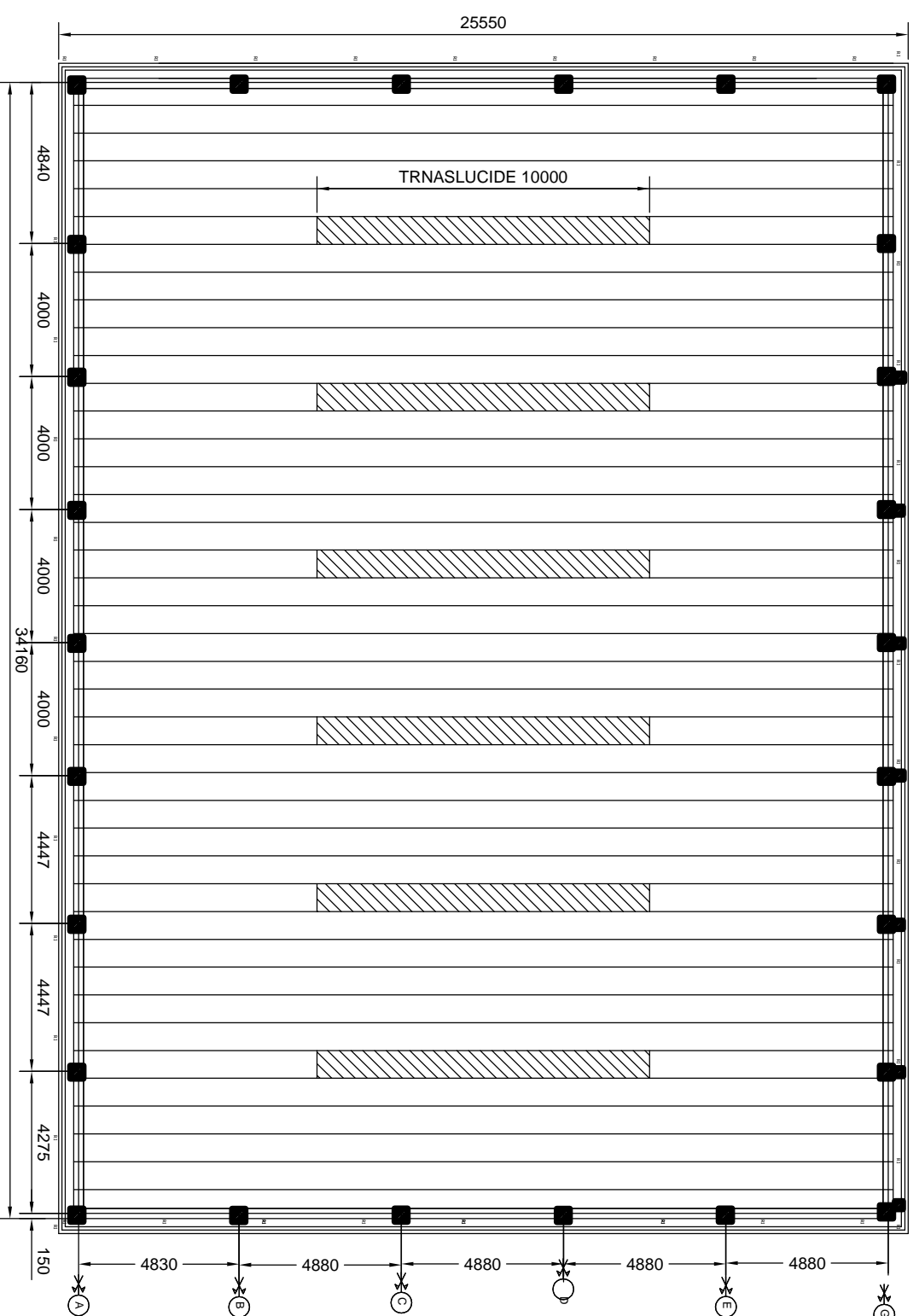
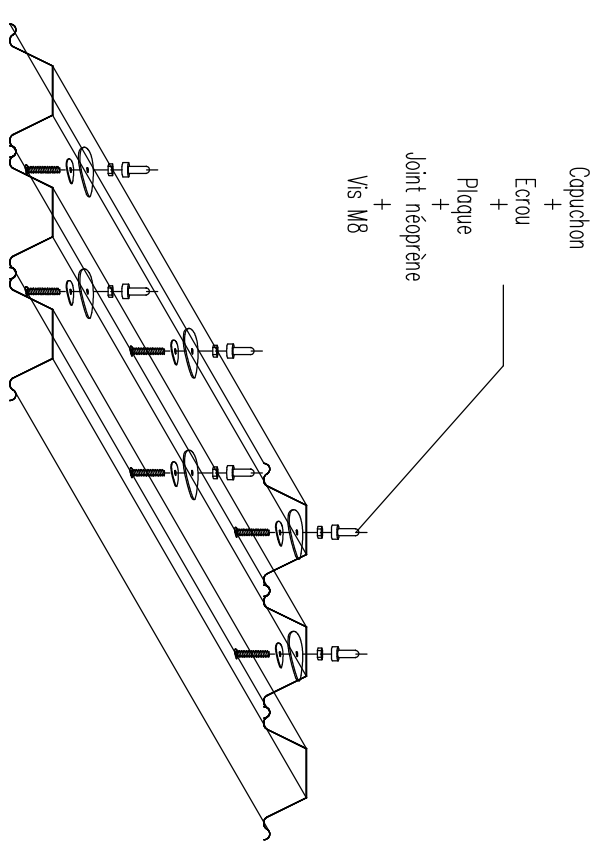
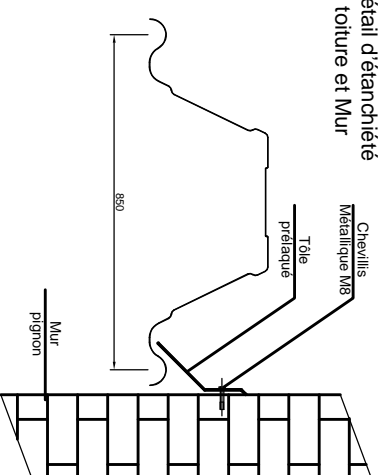

1 câble de contreventement tous les 3 tôles

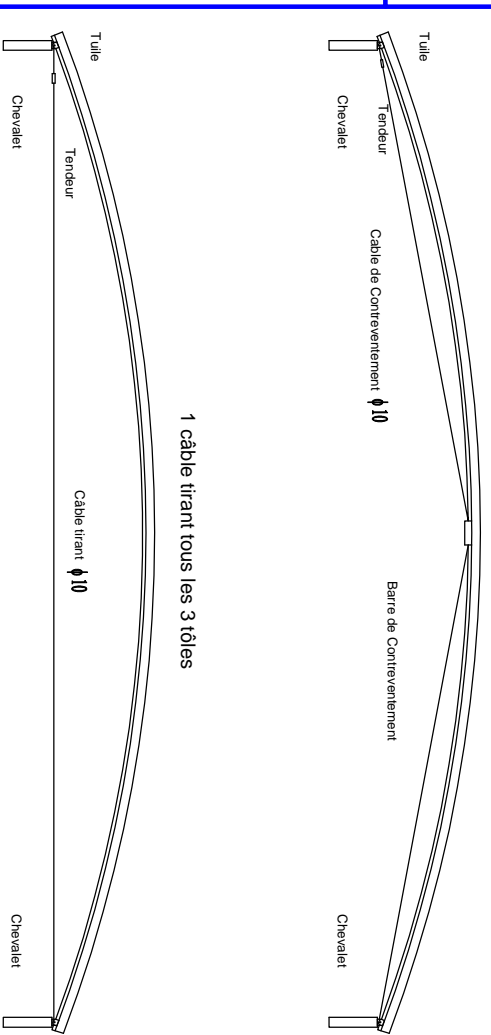

1 câble tirant tous les 3 tôles

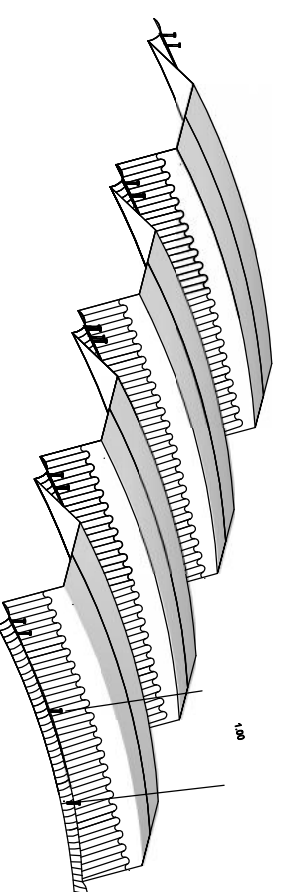
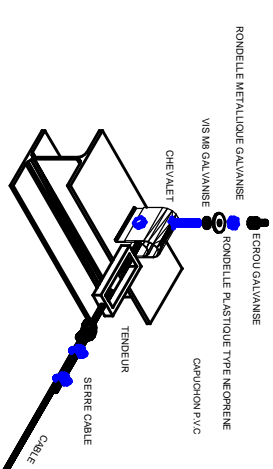
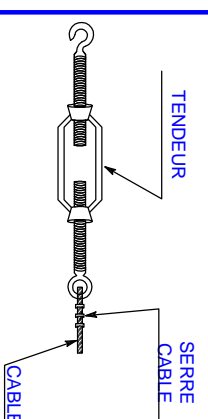

Caractéristique Mécanique BC 850

ÉPAISSEUR (mm)	PORTÉE (m)	Poids (kg/m)	INERTIE (cm ⁴)	MODULE DE FLÉXION (SUPERIEUR) (mm ⁴)	MODULE DE FLÉXION (INFÉRIEUR) (mm ⁴)	MODULE DE FLÉXION (MOYEN RESISTANCE) (mm ⁴)
1,35	25,00	14,74	287	41,60	43,90	9,80